



art. 0100 12"

saracinesca a lama senza scarico

cast-iron gate valve with stainless steel knife without discharge

vanne de fer fondu à lame en acier inox sans vidange

Gusseisen-Plattenschieber mit Edelstahl Platten ohne Abfluss

tajadera en hierro con hoja de acero inoxidable sin drenaje

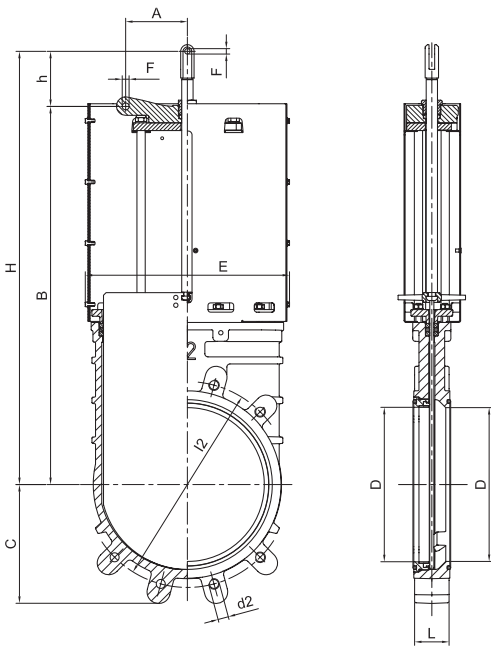

FLANGE - FLANGES DIN PN10

Ø"	l2	d2	fori holes
12"	400	M20	12

Ø"	Codice / Code	A	B	C	D	E	F	H	h	L	gr
12"	ARZO 0100 300 000	120	735	231	299	397	10,5	842	107	70	58.750

Senza asta / Without stem

Ø"	Codice / Code	gr
12"	ARZO 0100 300 SMO	57.050

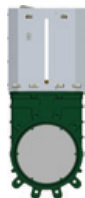

Con cilindro art. 0551 / With cylinder item 0551

Ø"	Codice / Code	h	H	gr
12"	ARZO 0100 300 551	780	1180	62.700

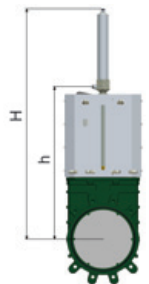

Con cilindro art. 0575 / With cylinder item 0575

Ø"	Codice / Code	h	H	gr
12"	ARZO 0100 300 575	785	1177	65.200

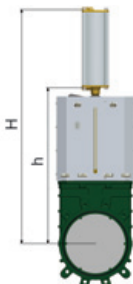

Con cilindro art. 0576 / With cylinder item 0576

Ø"	Codice / Code	h	H	gr
12"	ARZO 0100 300 576	785	1177	65.650

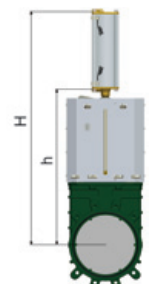

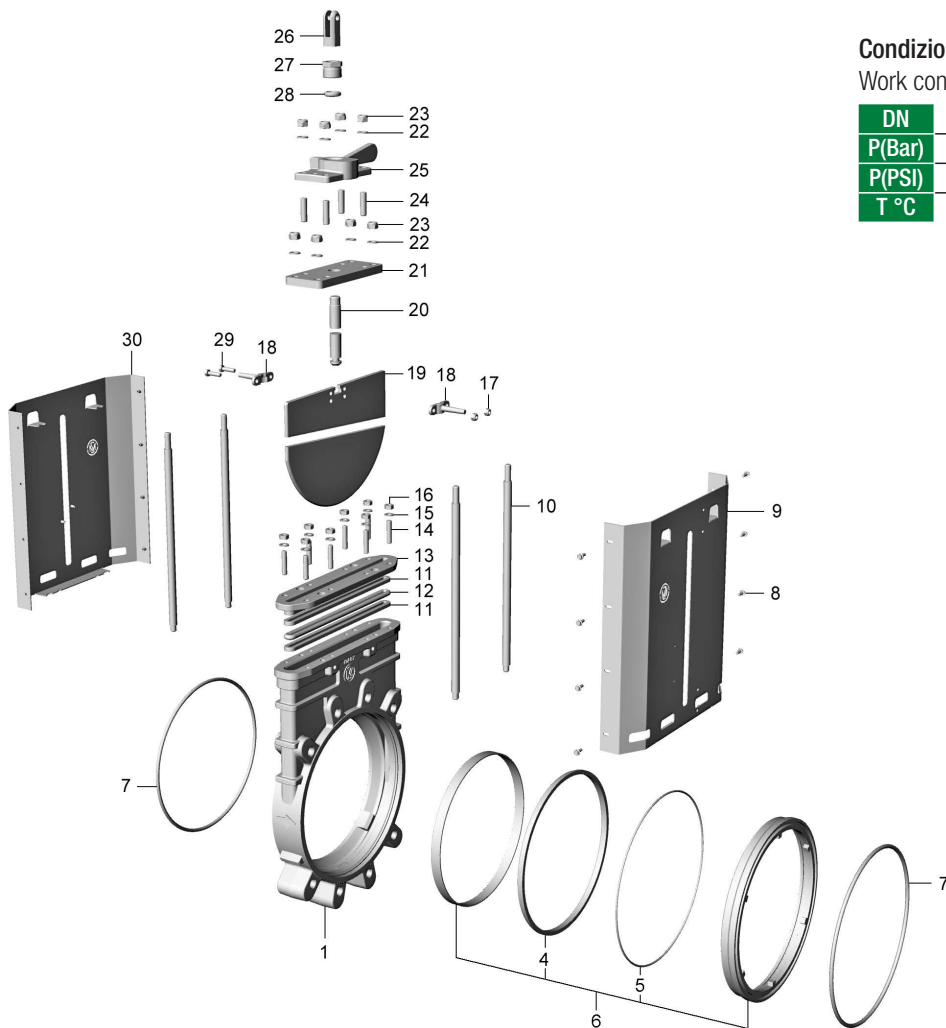

Condizioni di esercizio

Work conditions

DN	12"
P(Bar)	6
P(PSI)	90
T °C	-15 +80

POS.	CODICE / CODE	DENOMINAZIONE	DENOMINATION	MATERIALE	MATERIAL
1	FGZO 0100 300 001	CORPO "EURO"	BODY "EURO"	GHISA G250 UNI EN 1561	G250 UNI EN 1561 CAST IRON
4	GGOM 0100 300 004	ANELLO DI TENUTA	ESTATE RING	GOMMA EPDM	EPDM RUBBER
5	..OR 0100 300 017	OR 42100 (Øi 304,39×3,53)	O RING 42100 (Øi 304,39×3,53)	GOMMA NBR 70	NBR 70 RUBBER
6	SEMI 0100 300 008	MANICOTTO CON GUARNIZIONI	SLEEVE WITH GASKETS		
7	..OR 0020 250 002	OR 257 (Øi 316,9×6,99)	O RING 257 (Øi 316,9×6,99)	GOMMA NBR 70	NBR 70 RUBBER
8	VTAC 0120 100 022	VITE TE M5×14	SCREW TE M5×14	ACCIAIO INOX AISI 304	AISI 304 STAINLESS STEEL
9	SAZO 0100 300 040	CALOTTA FEMMINA	FEMALE CLOSING CAP	ACCIAIO ZINCATO	ZINC PLATED STEEL
10	TAZO 0100 300 010	COLONNA	STEM	ACCIAIO INOX AISI 304	AISI 304 STAINLESS STEEL
11	GUNY 0100 300 013	ANELLO TRECCIA 8×8	BRAID RING 8×8	SINTETICO + PTFE	SYNTHETIC + PTFE
11	GUNY 0100 300 009	ANELLO TRECCIA 10×10	BRAID RING 10×10	SINTETICO + PTFE	SYNTHETIC + PTFE
12	GGOM 0100 300 014	ANELLO OR Ø10	O RING Ø10	GOMMA EPDM	EPDM RUBBER
13	FGZO 0100 300 006	PREMITRECCIA	GASKET PRESSER	GHISA G250 UNI EN 1561	UNI EN 1561 CAST IRON
14	VTAC 0090 150 011	PRIGIONIERO M10×48	STUD M10×48	ACCIAIO INOX AISI 304	AISI 304 STAINLESS STEEL
15	ROAC 0090 150 016	ROSETTA Ø20×10,5×2	WASHER Ø20×10,5×2	ACCIAIO INOX AISI 304	AISI 304 STAINLESS STEEL
16	DAAC 0090 150 015	DADO M10	NUT M10	ACCIAIO INOX AISI 304	AISI 304 STAINLESS STEEL
17	DAAC 0080 200 021	DADO AUTOBLOCCANTE M8	SELF-LOCKING NUT M8	ACCIAIO INOX AISI 304	AISI 304 STAINLESS STEEL
18	FOZO 0100 250 018	MORSETTO INDICE	INDICATOR CLAMP	OTTONE UNI EN 1982	UNI EN 1982 BRASS
19	SAZO 0100 300 002	LAMA	KNIFE	ACCIAIO INOX AISI 304	AISI 304 STAINLESS STEEL
20	TOZO 0100 300 003	ASTA	STEM	OTTONE UNI EN 12164	UNI EN 12164
21	SAZO 0100 300 012	PIASTRA FORATA	DRILLED PLATED	ACCIAIO ZINCATO	ZINC PLATED STEEL
22	ROAC 0620 200 003	GROWER Ø21×13×2,5	GROWER Ø21×13×2,5	ACCIAIO INOX AISI 304	AISI 304 STAINLESS STEEL
23	DAAC 0092 150 006	DADO M12	NUT M12	ACCIAIO ZINCATO	ZINC PLATED STEEL
24	VTAC 0100 300 019	PRIGIONIERO M12×45	STUD M12×45	ACCIAIO INOX AISI 304	AISI 304 STAINLESS STEEL
25	FGZO 0100 250 005	TESTATA	HEAD	GHISA G250 UNI EN 1561	G250 UNI EN 1561 CAST IRON
26	FOZO 0040 100 008	FORCELLA	FORK	OTTONE UNI EN 1982	UNI EN 1982 BRASS
27	TOZO 0074 200 007	PREMISTOPPA M35×2	NUT M35×2	OTTONE UNI EN 12164	UNI EN 12164 BRASS
28	SPZO 0030 100 006	GUARNIZIONE Ø32×22,5×8	GASKET Ø32×22,5×8	POLIMERO	POLYMER
29	VTAC 0080 200 020	VITE TE M8×30	SCREW TE M8×30	ACCIAIO INOX AISI 304	AISI 304 STAINLESS STEEL
30	SAZO 0100 300 041	CALOTTA MASCHIO	MALE CLOSING CAP	ACCIAIO ZINCATO	ZINC PLATED STEEL