



art. 0102

saracinesca a lama senza scarico a volante

cast-iron gate valve with stainless steel knife without discharge with handwheel

vanne de fer fondu à lame en acier inox sans vidange avec volant à main

Gusseisen-Plattenschieber mit Edelstahl Platten ohne Abfluss mit Handrad

tajadera en hierro con hoja de acero inoxidable sin drenaje con volante

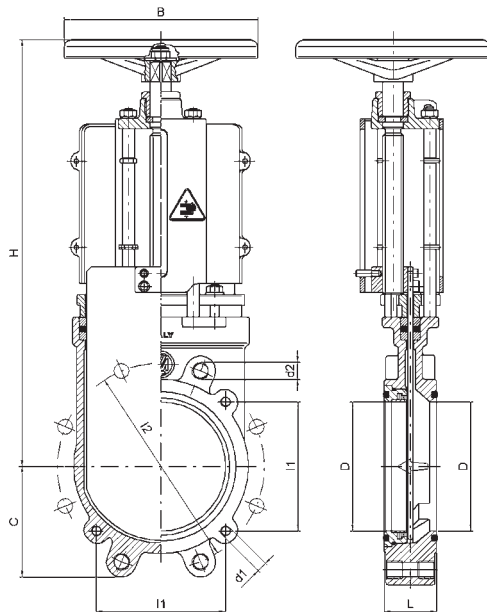

FLANGE - FLANGES DIN PN10

Ø"	I2	d2	fori holes
4"	180	M16	8
6"	240	M20	8
8"	295	M20	8

Ø"	B	C	D	H	L	I1	d1	gr ~
4"	225	102	100	412	50	150	2xM12	10.500
6"	225	130	150	495	60	150	4xM12	16.800
8"	250	156	200	588	60	180	4xM12	22.700

Codici di ordinazione

Purchase article numbers

	4"	6"	8"
Saracinesca a lama a volante Knife gate valve with handwheel	ARZO 0102 100 000	ARZO 0102 150 000	ARZO 0102 200 000

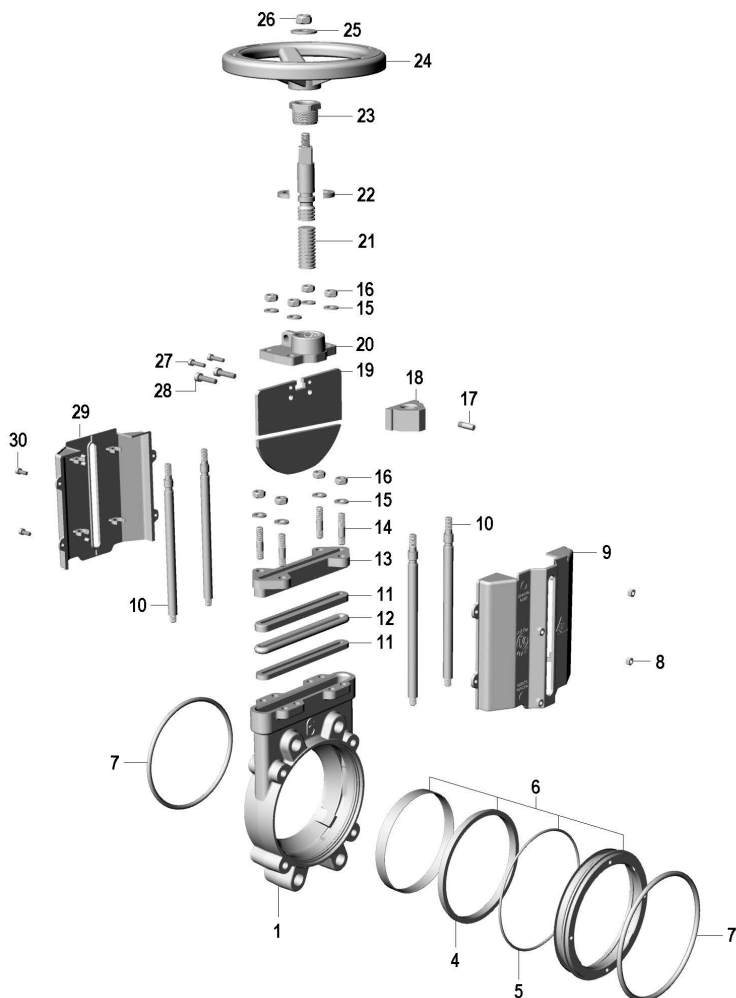

Condizioni di esercizio

Work conditions

DN	4" - 6"	8"
P(Bar)	10	8
P(PSI)	145	110
T °C	-15 +80	

Tabella conversione Ø"(in) - DN (mm)

Ø"(in) - DN (mm) conversion table

Ø"	4"	6"	8"
DN	100	150	200

POS.	CODICE / CODE	DENOMINAZIONE	DENOMINATION	MATERIALE	MATERIAL
1	FGZO 0100 (DN) 001	CORPO "EURO" Ø"...	BODY "EURO" Ø"...	GHISA G250 UNI EN 1561	G250 UNI EN 1561 CAST IRON
4	GGOM 0090 (DN) 004	ANELLO DI TENUTA Ø"...	ESTATE RING Ø"...	GOMMA EPDM	EPDM RUBBER
5	..OR 0090 100 017	OR 4512 (Øi129,80 × 3,53) 4"	O RING 4512 (Øi129,80 × 3,53) 4"	GOMMA NBR 70	NBR 70 RUBBER
5	..OR 0090 150 017	OR 4675 (Øi171,05 × 3,53) 6"	O RING 4675 (Øi171,05 × 3,53) 6"	GOMMA NBR 70	NBR 70 RUBBER
5	..OR 0090 200 017	OR 4875 (Øi221,85 × 3,53) 8"	O RING 4875 (Øi221,85 × 3,53) 8"	GOMMA NBR 70	NBR 70 RUBBER
6	SEMI 0090 100 008	MANICOTTO 4" CON GUARNIZIONI	SLEEVE 4" WITH GASKETS		
6	SEMI 0100 150 008	MANICOTTO 6" CON GUARNIZIONI	SLEEVE 6" WITH GASKETS		
6	SEMI 0100 200 008	MANICOTTO 8" CON GUARNIZIONI	SLEEVE 8" WITH GASKETS		
7	..OR 0090 100 015	OR 206 (Øi127,0 × 5,34) 4"	O RING 206 (Øi127,0 × 5,34) 4"	GOMMA NBR 70	NBR 70 RUBBER
7	..OR 0020 100 010	OR 225 (Øi159,5 × 6,99) 6"	O RING 225 (Øi159,5 × 6,99) 6"	GOMMA NBR 70	NBR 70 RUBBER
7	..OR 0100 200 010	OR 241 (Øi 208,92 × 6,99) 8"	O RING 241 (Øi 208,92 × 6,99) 8"	GOMMA NBR 70	NBR 70 RUBBER
8	DAAC 0090 150 023	DADO AUTOBLOCCANTE M5	SELF-LOCKING NUT M5	ACCIAIO INOX AISI 304	AISI 304 STAINLESS STEEL
9	SPZO 0090 (DN) 12V	CALOTTA DI CHIUSURA	CLOSING CAP	NYLON + VETRO	NYLON + GLASS
10	TAZO 0090 (DN) 010	COLONNA Ø14 Ø"...	STEM Ø14 Ø"...	ACCIAIO INOX AISI 304	AISI 304 STAINLESS STEEL
11	GUNY 0090 (DN) 013	ANELLO TRECCIA 8×8 Ø"...	BRAID RING 8×8 Ø"...	SINTETICO + PTFE	SYNTHETIC + PTFE
12	GGOM 0090 (DN) 014	ANELLO OR Ø10 Ø"...	O RING Ø10 Ø"...	GOMMA EPDM	EPDM RUBBER
13	FAZO 0090 (DN) 006	PREMITRECCIA Ø"...	GASKET PRESSER Ø"...	ALLUMINIO	ALUMINIUM
14	VTAC 0090 150 011	PRIGIONIERO M10×48	STUD M10×48	ACCIAIO INOX AISI 304	AISI 304 STAINLESS STEEL
15	ROAC 0090 150 016	RONDELLA Ø21 × 10,5 × 2	WASHER Ø21 × 10,5 × 2	ACCIAIO INOX AISI 304	AISI 304 STAINLESS STEEL
16	DAAC 0090 150 015	DADO M10	NUT M10	ACCIAIO INOX AISI 304	AISI 304 STAINLESS STEEL
17	TOZO 0090 150 025	STELO INDICE M8×26	INDICATOR STEM M8×26	OTTONE UNI EN 12164	UNI EN 12164 BRASS
18	SOZO 0090 100 024	BLOCCETTO ATTACCO LAMA	BLOCK FOR KNIFE CONNECTION	OTTONE UNI EN 12165	UNI EN 12165 BRASS
18	SOZO 0090 150 024	BLOCCETTO ATTACCO LAMA 6"	BLOCK FOR KNIFE CONNECTION 6"	OTTONE UNI EN 12165	UNI EN 12165 BRASS
18	SOZO 0090 200 024	BLOCCETTO ATTACCO LAMA 8"	BLOCK FOR KNIFE CONNECTION 8"	OTTONE UNI EN 12165	UNI EN 12165 BRASS
19	SAZO 0090 (DN) 002	LAMA Ø"...	KNIFE Ø"...	ACCIAIO INOX AISI 304	AISI 304 STAINLESS STEEL
20	FGZO 0090 150 027	TESTATA SPECIALE	SPECIAL TOP HEAD	GHISA G250 UNI EN 1561	G250 UNI EN 1561 CAST IRON
20	FGZO 0090 200 027	TESTATA SPECIALE 8"	SPECIAL TOP HEAD 8"	GHISA G250 UNI EN 1561	G250 UNI EN 1561 CAST IRON
21	TOZO 0090 (DN) 026	ASTA FILETTATA Ø"...	SCREWED STEM Ø"...	OTTONE UNI EN 12164	UNI EN 12164 BRASS
22	SAZO 0090 150 028	SEMIANELLO	BAIL HALF-RING	ACCIAIO INOX AISI 304	AISI 304 STAINLESS STEEL
23	TOZO 0090 150 029	GHIERA M36×2	SCREWED RING M36×2	OTTONE UNI EN 12164	UNI EN 12164 BRASS
24	FGZO 0090 150 031	VOLANTINO Ø225	HANDWHEEL Ø225	GHISA	CAST IRON
24	FGZO 0090 200 031	VOLANTINO Ø250 8"	HANDWHEEL Ø250 8"	GHISA	CAST IRON
25	TAZO 0090 150 030	RONDELLA Ø36×13×3	WASHER Ø36×13×3	ACCIAIO INOX AISI 304	AISI 304 STAINLESS STEEL
26	DAAC 0092 150 006	DADO AUTOBLOCCANTE M12	SELF-LOCKING NUT M12	ACCIAIO ZINCATO	ZINC PLATED STEEL
27	VTAC 0080 150 020	VITE TCEI M6×20	SCREW TCEI M6×20	ACCIAIO INOX AISI 304	AISI 304 STAINLESS STEEL
27	VTAC 0020 100 009	VITE TCEI M8×16 (8")	SCREW TCEI M8×16 (8")	ACCIAIO INOX AISI 304	AISI 304 STAINLESS STEEL
28	VTAC 0020 100 009	VITE TCEI M8×16	SCREW TCEI M8×16	ACCIAIO INOX AISI 304	AISI 304 STAINLESS STEEL
29	SPZO 0090 (DN) 012	CALOTTA DI CHIUSURA	CLOSING CAP	NYLON + VETRO	NYLON + GLASS
30	VTAC 0090 150 022	VITE TCEI M5×14	SCREW TCEI M5×14	ACCIAIO INOX AISI 304	AISI 304 STAINLESS STEEL