

# APS 96



POMPE A MEMBRANA AD ALTA PRESSIONE  
HIGH PRESSURE DIAPHRAGM PUMPS  
POMPES A MEMBRANE A HAUTE PRESSION  
BOMBAS A MEMBRANA DE ALTA PRESSION  
HOCHDRUCK-MEMBRANPUMPEN



Configurazione: 4 membrane in NBR (Desmopan® e Viton a richiesta). Parti a contatto con il liquido: alluminio anodizzato. Di serie: accumulatore di pressione e valvola di sicurezza. A richiesta: protezione p.d.f..

Configuration: 4 diaphragms in NBR (Desmopan® and Viton available on request). Parts in contact with spray liquid: anodized aluminium. Standard: pressure accumulator and safety valve. On request: PTO protection.

Configuration : 4 membranes en NBR (Desmopan® et Viton à la demande). Parties au contact du liquide : aluminium anodisé. De série : accumulateur de pression et soupape de sécurité. À la demande : protection prise de force.

Configuración: 4 membranas en NBR (Desmopan® y Viton bajo pedido). Partes en contacto con el líquido: aluminio anodizado. De serie: acumulador de presión y válvula de seguridad. Bajo pedido: protección toma de fuerza (t.d.f.).

Konfigurierung: 4 Membranen aus NBR (Desmopan® und Viton auf Wunsch). Teile im Kontakt mit der Flüssigkeit: eloxiertes Aluminium. Serienmäßig: Druckspeicher und Sicherheitsventil. Auf Wunsch: Zapfwellenschutz.

## APS 96

	0 bar - 0 p.s.i				20 bar - 290 p.s.i				30 bar - 435 p.s.i				40 bar - 580 p.s.i				50 bar - 725 p.s.i									
RPM	L/min		U.S.g.p.m.		HP		kW		L/min		U.S.g.p.m.		HP		kW		L/min		U.S.g.p.m.		HP		kW		kg	lb
400	74	19,5	0,7	0,5	68	18,0	3,7	2,8	67	17,7	5,3	3,9	66	17,4	6,8	5,0	65	17,2	8,5	6,3	22,5	49,6				
450	83	21,9	1,0	0,7	77	20,3	4,3	3,1	75	19,8	6,0	4,4	74	19,5	7,7	5,7	73	19,3	9,5	7,0						
500	89	23,5	1,2	0,9	85	22,5	4,8	3,6	83	21,9	6,8	5,0	81	21,4	8,7	6,4	80	21,1	10,6	7,8						
550	94	24,8	1,5	1,1	91	24,0	5,3	3,9	90	23,8	7,5	5,5	89	23,5	9,5	7,0	88	23,2	11,7	8,6						

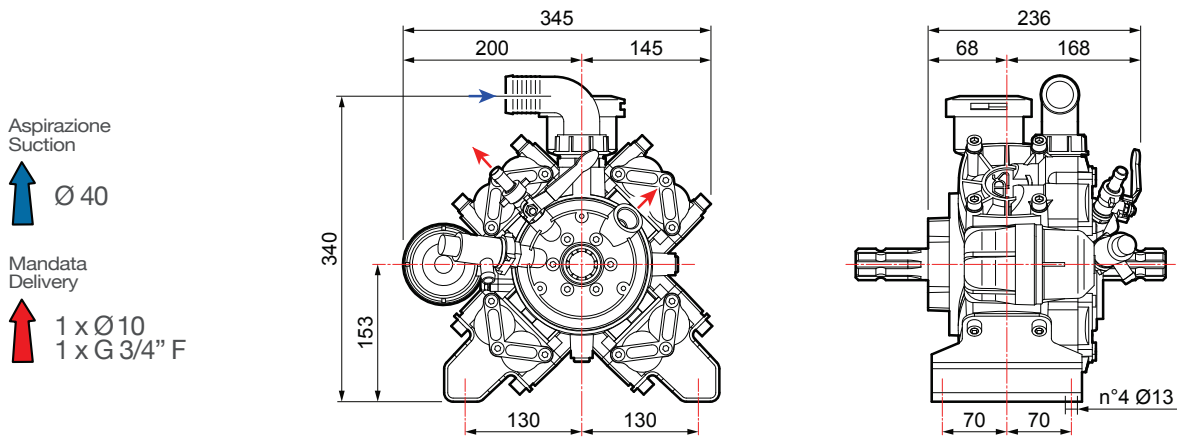

**VERSIONI STANDARD · STANDARD VERSIONS · VERSIONS STANDARD · VERSIONES ESTÁNDAR · STANDARDAUSFÜHRUNGEN**

Versioni derivate · Versions adapted · Versions dérivées · Versiones derivadas · Von der Standardversion abgeleitete Ausführungen

**A**



Albero passante  
Through shaft  
Arbre traversant  
Cigüeñal pasante  
Durchgangswelle

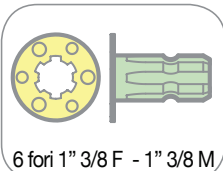

6 fori 1" 3/8 F - 1" 3/8 M

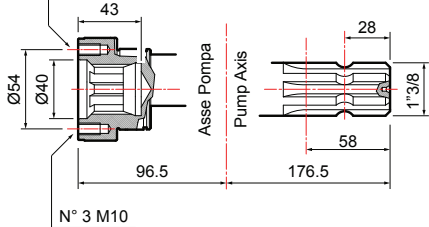

N° 3 M8  
43  
Ø64  
Ø40  
96.5  
N° 3 M10  
Asse Pompa  
Pump Axis  
28  
176.5  
1" 3/8  
58

**1**



Flangiata a motore idraulico  
Flanged to hydraulic motor  
Bridée à un moteur hydraulique  
Conexión con brida a motor hidráulico  
An Hydraulikmotor geflanscht

**2**



Flangiata a moltiplicatore  
Coupled to overgearbox  
Bridée à un multiplicateur  
Conexión con brida a multiplicador  
An Übersetzungsgetriebe geflanscht

**3**



Kit Cardano  
Male PTO kit  
Kit Cardan  
Kit Cardán  
Kardankit

**4**



Kit Cilindrico  
Cylindrical kit  
Kit cylindrique  
Kit cilindrico  
Zylinderkit

**5**



Riduttore di giri  
Reduction gearbox  
Réducteur de tours  
Reductor de revoluciones  
Untersetzungsgetriebe

**6**



Kit attacco rapido  
Quick coupling kit  
Kit accouplement rapide  
Kit conexión rápida  
Schnellkupplungsset

**7**



Kit Puleggia  
Pulley kit  
Kit Poulie  
Kit Polea  
Riemenscheibenkit

**B**



Albero passante  
Through shaft  
Arbre traversant  
Cigüeñal pasante  
Durchgangswelle

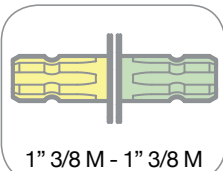

1" 3/8 M - 1" 3/8 M

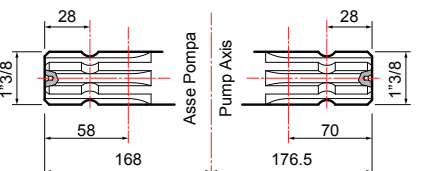

28  
1" 3/8  
58  
168  
Asse Pompa  
Pump Axis  
28  
176.5  
1" 3/8  
70



# APS Series

APS 96

Pompe a Membrana - Diaphragm Pumps

550 RPM

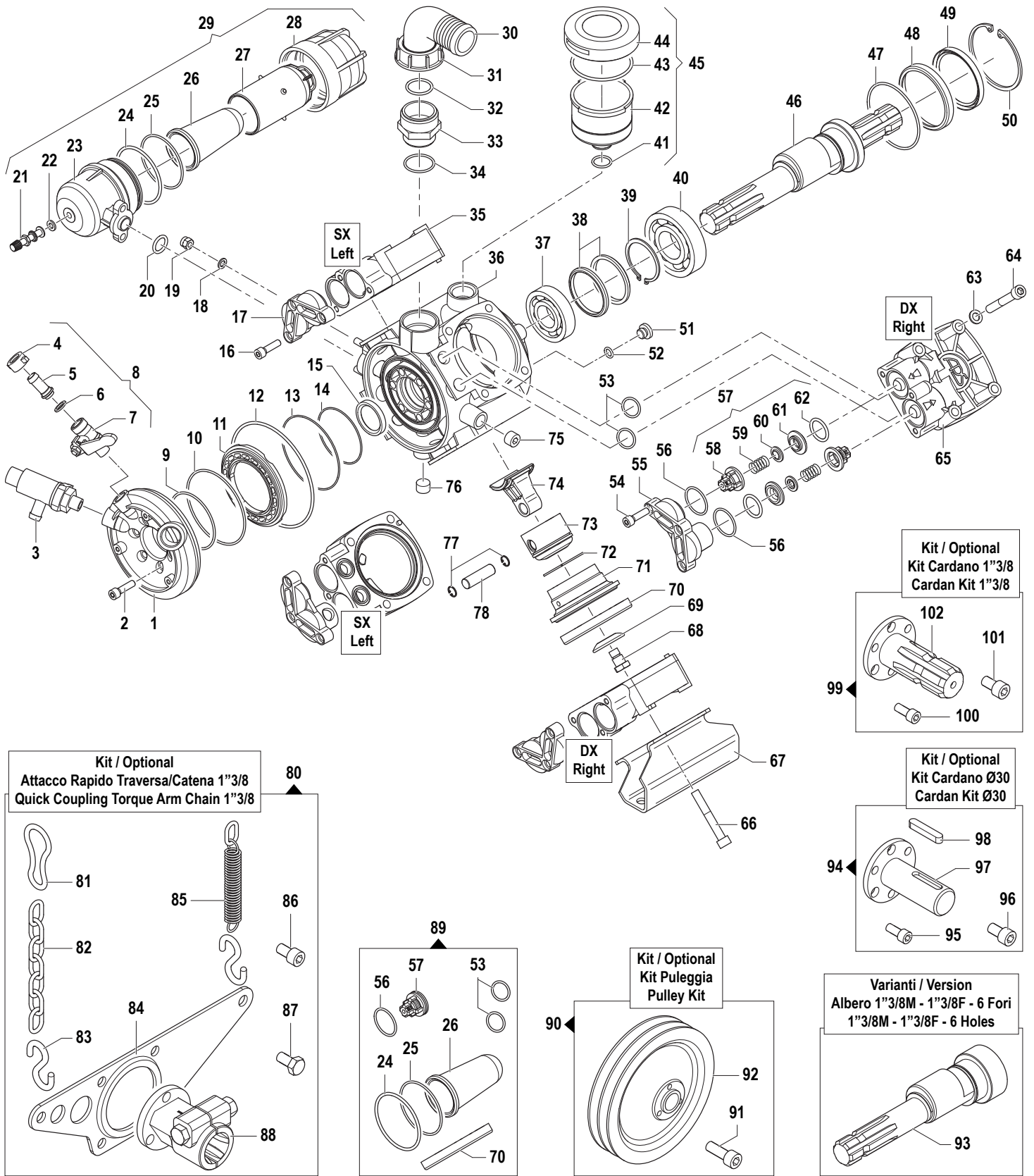

**Pompa Base**  
**Standard Pump**

Albero Passante 1"3/8 M-M  
1"3/8 M-M Throughshaft

### APS 96

N°	Cod.	Descrizione	Description	Note	Qty	Model
1	1009 0202	Flangia Collettore	Manifold Flange		1	
2	3609 0006	Vite	Screw	M8x30	6	
3	1219 0051	Gruppo Valvola Sicurezza	Safety Valve Assembly	50bar 20-100L	1	
4	1200 0038	Galletto	Wing Nut	G1/2"	1	
5	2802 0018	Raccordo p.g. Mandata	Delivery Hose Tail	Ø8x10	1	
6	1209 0013	Guarnizione	Gasket	Ø12x18x2	1	
7	2826 0029	Rubinetto DX	Right Tap	G3/8-1/2"	1	
8	1214 0015	Gruppo Rubinetto	Complete Tap		1	
9	1210 0431	Guarnizione OR	O-Ring	Ø2,62x75,87	1	
10	1210 0206	Guarnizione OR	O-Ring	Ø2,62x101,27	1	
11	0602 0059	Distanziale in Plastica	Plastic Spacer	BIANCO /WHITE	1	
12	1210 0349	Guarnizione OR	O-Ring	Ø3,53x142,5	1	
13	1210 0345	Guarnizione OR	O-Ring	Ø1,78x101,32	1	
14	1210 0347	Guarnizione OR	O-Ring	Ø1,78x75,92	1	
15	0019 0083	Anello Tenuta	Oil Seal	Ø35x47x7	1	
16	3609 0006	Vite	Screw	M8x30	6	
17	3202 0197	Tappo Valv. Aspir./Mand. SX	Plug		2	
18	2811 0004	Rondella	Washer	Ø8,4x14x1,6	2	
19	0604 0039	Dado	Nut	M8x9,5	2	
20	1210 0111	Guarnizione OR	O-Ring	Ø3,53x18,64	1	
21	3610 0003	Valvola Aria	Air Valve		1	
22	1209 0033	Guarnizione	Gasket	Ø14x7,5x2	2	
23	0003 0026	Accumulatore Press. Sup.	Pressure Accumulator		1	
24	1210 0165	Guarnizione OR Viton®	Viton® O-Ring	Ø2,62x71,12	1	
25	1210 0132	Guarnizione OR	O-Ring	Ø3,53x74,61	1	
26	1800 0094	Membrana Accumulatore	Diaphragm		1	
27	0460 0028	Calotta Sostegno Membrana	Diaphragm Support Cap		1	
28	0002 0029	Accumulatore Press. Infer.	Pressure Accumulator		1	
29	1225 0013	Gruppo Accumul. Pressione	Pressure Accumulator Ass.y		1	
30	2801 0055	Raccordo p.g. Curvo	Elbow Coupling	Ø40	1	
31	1200 0054	Galletto	Wing Nut	1"1/2 GAS	1	
32	1210 0180	Guarnizione OR	O-Ring	Ø3x29	1	
33	2000 0086	Nipplo	Nipple	G1"1/4-G1"1/2	1	
34	1210 0032	Guarnizione OR	O-Ring	Ø2,62x34,6	1	
35	3218 0103	Testata Pompa SX	Left Pump Manifold		2	
36	0403 0127	Carter Pompa	Pump Crankcase		1	
37	0438 0010	Cuscinetto a Sfere	Ball Bearing	Ø35x72x17	1	
38	0010 0021	Anello Tenuta Biella	Connecting Rod Ring	Ø68x59x5,5	2	
39	3019 0001	Seeger Esterno	Outer Seeger	Ø55	1	
40	0438 0001	Cuscinetto a Sfere	Ball Bearing	Ø55x90x18	1	
41	1210 0002	Guarnizione OR	O-Ring	Ø2,62x20,7	1	
42	0421 0012	Compensatore Volumetrico	Volumetric Compensator		1	
43	1210 0373	Guarnizione OR	O-Ring	Ø3,53x73,03	1	
44	0402 0143	Coperchio Compens. Volum.	Volum. Compensator Cover		1	
45	1208 0015	Kit Compensatore Volumetrico	Volumetric Compensator Kit		1	
46	0001 0518	Albero Passante	Throughshaft	1"3/8 M-M	1	
47	1210 0225	Guarnizione OR	O-Ring	Ø2,62x88,57	1	
48	0009 0192	Anello	Ring		1	
49	0019 0093	Anello Tenuta	Oil Seal	Ø70x85x8	1	
50	3020 0002	Seeger Interno	Inner Seeger	Ø90	1	
51	3200 0010	Tappo Esagonale	Plug	G1/4"	1	
52	1210 0044	Guarnizione OR	O-Ring	Ø2,62x 9,92	1	
53	1210 0047	Guarnizione OR	O-Ring	Ø2,62x22,22	8	
54	3609 0006	Vite	Screw	M8x30	6	
55	3202 0217	Tappo Valv. Aspir./Mand. DX	Plug		2	
56	1210 0032	Guarnizione OR	O-Ring	Ø2,62x34,6	8	
57	1220 0035	Gruppo Valvola Asp./Mand.	Suct./Delivery Valve Ass.y kit		8	
58	1205 0029	Gabbia Valvola Aspir./Mand.	Suction/Delivery Valve Cage		8	
59	1802 0015	Molla (Filo Ø0,8)	Spring (Wire Ø0,8)	Øe11x17	8	
60	3604 0023	Valvola Aspiraz./Mandata	Suction/Delivery Valve		8	
61	3009 0115	Sede Valvola Aspir./Mand.	Suction/Delivery Valve Seat		8	
62	1210 0443	Guarnizione OR	O-Ring	Ø3,53x25,8	8	
63	2811 0098	Rondella	Washer	Ø10,5x18x2	8	
64	3609 0078	Vite	Screw	M10x70	16	
65	3218 0102	Testata Pompa DX	Right Pump Manifold		2	
67	2400 0068	Piede Sostegno Pompa	Pump Mounting Bracket		2	
68	3605 0005	Vite Speciale Tenuta Membr.	Diaphragm Holder Screw	M12x1,5	4	
69	0602 0010	Disco Tenuta Membrana	Disc		4	
70	1800 0088	Membrana Pompa	Diaphragm	Gomma Nitrilica Buna Rubber	4	
	1800 0096	Membrana Pompa	Diaphragm	Desmopan ®	4	
	1800 0095	Membrana Pompa	Diaphragm	Viton ®	4	
71	0400 0074	Camicia	Piston Sleeve	Ø58x8,9	4	
72	0020 0008	Anello Compressione	Compression Ring	Ø58x2x2,3	4	
73	2409 0067	Pistone	Piston	Ø58	4	

### 550 RPM

N°	Cod.	Descrizione	Description	Note	Qty	Model
74	0205 0060	Kit Biella 4SET	Connecting Rod Assembly		1	
75	3200 0019	Tappo Esagonale	Plug	GC3/8x10	1	
76	3200 0019	Tappo Esagonale	Plug	GC3/8x10	1	
77	3020 0029	Seeger Interno	Inner Seeger	Ø14	8	
78	3011 0021	Spinotto	Gudgeon Pin	Ø14x47,5	4	

#### Kit

##### Optional

80	5002 0003	Kit Traversa Attacco Rapido	Torque Arm - Quick Coup. Kit		1	
81	1202 0009	Gancio	Hook		2	
82	0465 0001	Catena ad Anelli	Chain	500 mm	2	
83	1202 0006	Gancio	Hook	Ø6	2	
84	3221 0003	Traversa Attacco Rapido	Torque Arm - Quick Coupling		1	
85	1802 0040	Molla (Filo Ø2,5) + Gancio	Spring (Wire Ø2,5) + Hook	Øe20x100	1	
86	3609 0026	Vite Testa Esagono	Exagonal Screw	M10x18	3	
87	3607 0225	Vite Testa Esagonale	Hexagonal Screw	M10x20	4	
88	1407 0046	Innesto Calettato	Quick Coupling	Ø1"3/8 F	1	

#### Kit Manutenzione

##### Maintenance Kit

89	5026 0087	Kit Manutenzione Ordinaria	Ordinary Maintenance Kit		1	
----	-----------	----------------------------	--------------------------	--	---	--

#### Kit

##### Optional

90	5001 0043	Kit Puleggia	Pulley Kit	3A - Øp292mm	1	
	5001 0045	Kit Puleggia	Pulley Kit	3A - Øp350mm	1	
	5001 0029	Kit Puleggia	Pulley Kit	3B - Øp290mm	1	
91	3609 0161	Vite	Screw	M10x45	3	Solo/Only 3A
	3609 0095	Vite	Screw	M10x50	3	Solo/Only 3B
92	2424 0016	Puleggia	Pulley	3A - Øp292mm	1	
	2424 0035	Puleggia	Pulley	3A - Øp350mm	1	
	2424 0017	Puleggia	Pulley	3B - Øp290mm	1	

#### Varianti

##### Version

93	0001 0515	Albero Passante	Throughshaft	1"3/8 M-F	1	
----	-----------	-----------------	--------------	-----------	---	--

#### Kit

##### Optional

94	5003 0014	Kit Cardano Cilindrico	Cylindric Cardan Kit	Ø30	1	
	5003 0041	Kit Cardano Cilindrico	Cylindric Cardan Kit	1"	1	
95	3609 0157	Vite	Screw	M8x18	3	
96	3609 0026	Vite	Screw	M10x18	3	
97	0027 0017	Albero	Shaft	Ø30 Cil. / Cyl.	1	
	0027 0023	Albero	Shaft	1" Cil. / Cyl.	1	
98	1602 0018	Linguetta	Key	8x7x40	1	Solo/Only Ø30

#### Kit

##### Optional

99	5003 0007	Kit Cardano	Cardan Kit	1"3/8	1	
100	3609 0026	Vite	Screw	M10x18	3	
101	3609 0157	Vite	Screw	M8x18	3	
102	0027 0016	Albero	Shaft	1"3/8	1	