

IDS 1201-1401

POMPE A MEMBRANA AD ALTA PRESSIONE
HIGH PRESSURE DIAPHRAGM PUMPS
POMPES A MEMBRANE A HAUTE PRESSION
BOMBAS A MEMBRANA DE ALTA PRESSION
HOCHDRUCK-MEMBRANPUMPEN



Configurazione: 3 membrane in NBR (Desmopan® e Viton a richiesta). Parti a contatto con il liquido: ottone. Di serie: accumulatore di pressione, valvola di sicurezza. A richiesta: protezione p.d.f.













Configuration: 3 diaphragms in NBR (Desmopan® and Viton available on request). Parts in contact with spray liquid: brass. Standard: pressure accumulator, safety valve. On request: PTO protection.

Configuration: 3 membranes en NBR (Desmopan® et Viton à la demande). Parties au contact du liquide : laiton. De série: accumulateur de pression et soupape de sécurité. À la demande : protection prise de force.













Configuración: 3 membranas en NBR (Desmopan® y Viton bajo pedido). Partes en contacto con el líquido: latón. De serie: acumulador de presión y válvula de seguridad. Bajo pedido: protección toma de fuerza (t.d.f.).

Konfigurierung: 3 Membranen aus NBR (Desmopan® und Viton auf Wunsch). Teile im Kontakt mit der Flüssigkeit: Messing. Serienmäßig: Druckspeicher und Sicherheitsventil. Auf Wunsch: Zapfwellenschutz.

IDS 1201

	0 bar - 0 p.s.i.				20 bar - 290 p.s.i.				30 bar - 435 p.s.i.				40 bar - 580 p.s.i.				50 bar - 725 p.s.i.					
																						
RPM	l/min	U.S.g.p.m.	HP	kW	l/min	U.S.g.p.m.	HP	kW	l/min	U.S.g.p.m.	HP	kW	l/min	U.S.g.p.m.	HP	kW	l/min	U.S.g.p.m.	HP	kW	kg	lb
400	94	24,7	1,6	1,2	92	24,3	4,8	3,5	92	24,2	6,9	5,1	91	23,9	9,0	6,6	90	23,6	11,3	8,3	53	117
450	105	27,6	1,9	1,4	103	27,1	5,6	4,1	102	26,9	8,1	5,9	101	26,7	10,3	7,6	101	26,5	12,8	9,4		
500	116	30,5	2,2	1,6	114	30,0	6,2	4,5	113	29,9	8,7	6,4	113	29,7	11,4	8,4	111	29,4	14,1	10,3		
550	124	32,8	2,6	1,9	122	32,3	7,0	5,1	122	32,2	9,9	7,3	121	32,0	12,7	9,3	121	31,8	15,5	11,4		

IDS 1401

	0 bar - 0 p.s.i.				20 bar - 290 p.s.i.				30 bar - 435 p.s.i.				40 bar - 580 p.s.i.				50 bar - 725 p.s.i.					
																						
RPM	l/min	U.S.g.p.m.	HP	kW	l/min	U.S.g.p.m.	HP	kW	l/min	U.S.g.p.m.	HP	kW	l/min	U.S.g.p.m.	HP	kW	l/min	U.S.g.p.m.	HP	kW	kg	lb
400	106	28,0	1,1	0,8	103	27,2	5,2	3,8	102	26,9	7,6	5,6	102	26,9	9,8	7,2	101	26,7	12,1	8,9	45	99
450	119	31,4	1,2	0,9	116	30,6	6,0	4,4	115	30,4	8,6	6,3	114	30,1	11,4	8,4	114	30,1	13,6	10,0		
500	131	34,6	1,6	1,2	129	34,1	6,8	5,0	128	33,8	9,8	7,2	127	33,5	12,8	9,4	125	33,0	15,6	11,5		
550	137	36,2	2,6	1,9	136	35,9	7,2	5,3	135	35,7	10,3	7,6	135	35,7	13,5	9,9	135	35,7	16,6	12,2		

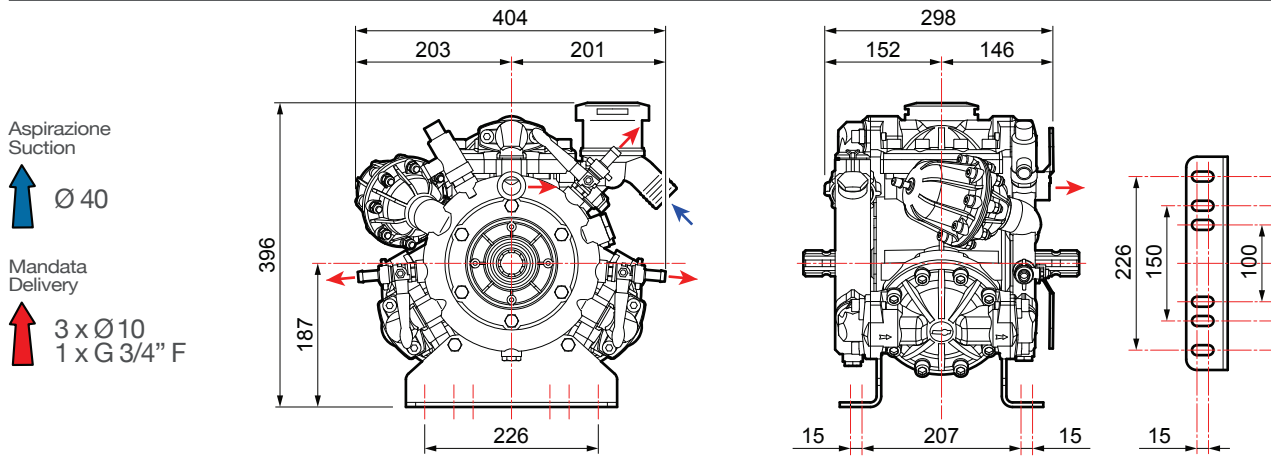

VERSIONI STANDARD · STANDARD VERSIONS · VERSIONS STANDARD · VERSIONES ESTÁNDAR · STANDARDAUSFÜHRUNGEN

Versioni derivate · Versions adapted · Versions dérivées · Versiones derivadas · Von der Standardversion abgeleitete Ausführungen

A



Albero passante
Through shaft
Arbre traversant
Cigüeñal pasante
Durchgangswelle

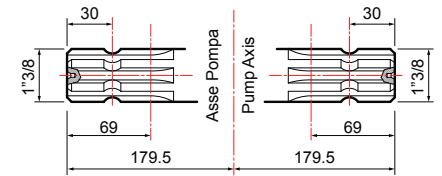
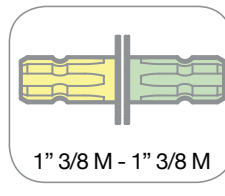

1



Flangiata a motore idraulico
Flanged to hydraulic motor
Bridée à un moteur hydraulique
Conexión con brida a motor hidráulico
An Hydraulikmotor geflanscht

B



Albero passante
Through shaft
Arbre traversant
Cigüeñal pasante
Durchgangswelle

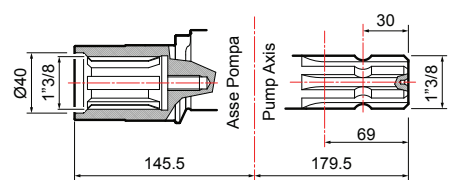
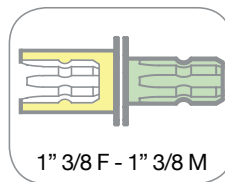

1



Flangiata a moltiplicatore
Coupled to overgearbox
Bridée à un multiplicateur
Conexión con brida a multiplicador
An Übersetzungsgetriebe geflanscht

2



Kit Puleggia
Pulley kit
Kit Poulie
Kit Polea
Riemenscheibenkit



IDS Series

IDS 1201 - IDS 1401

Pompe a Membrana - Diaphragm Pumps

550 RPM

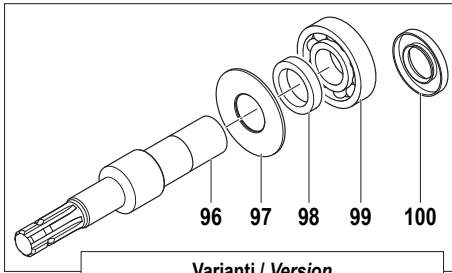

Varianti / Version
Albero Passante Femmina 1"3/8M - 1"3/8F
1"3/8M - 1"3/8F Throughshaft

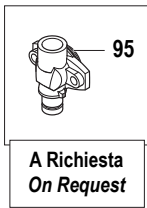

A Richiesta
On Request

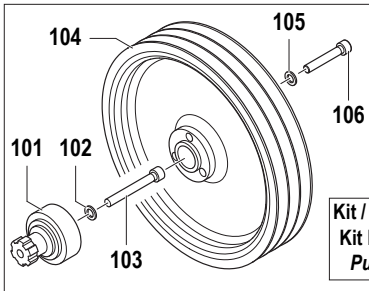
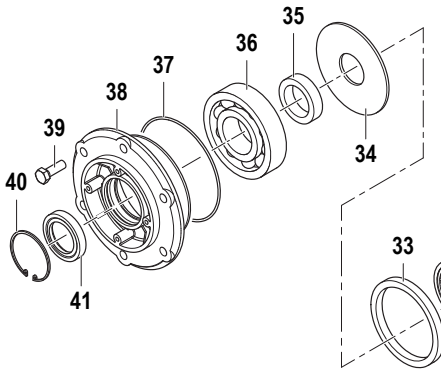

107
Kit / Optional
Kit Puleggia
Pulley Kit

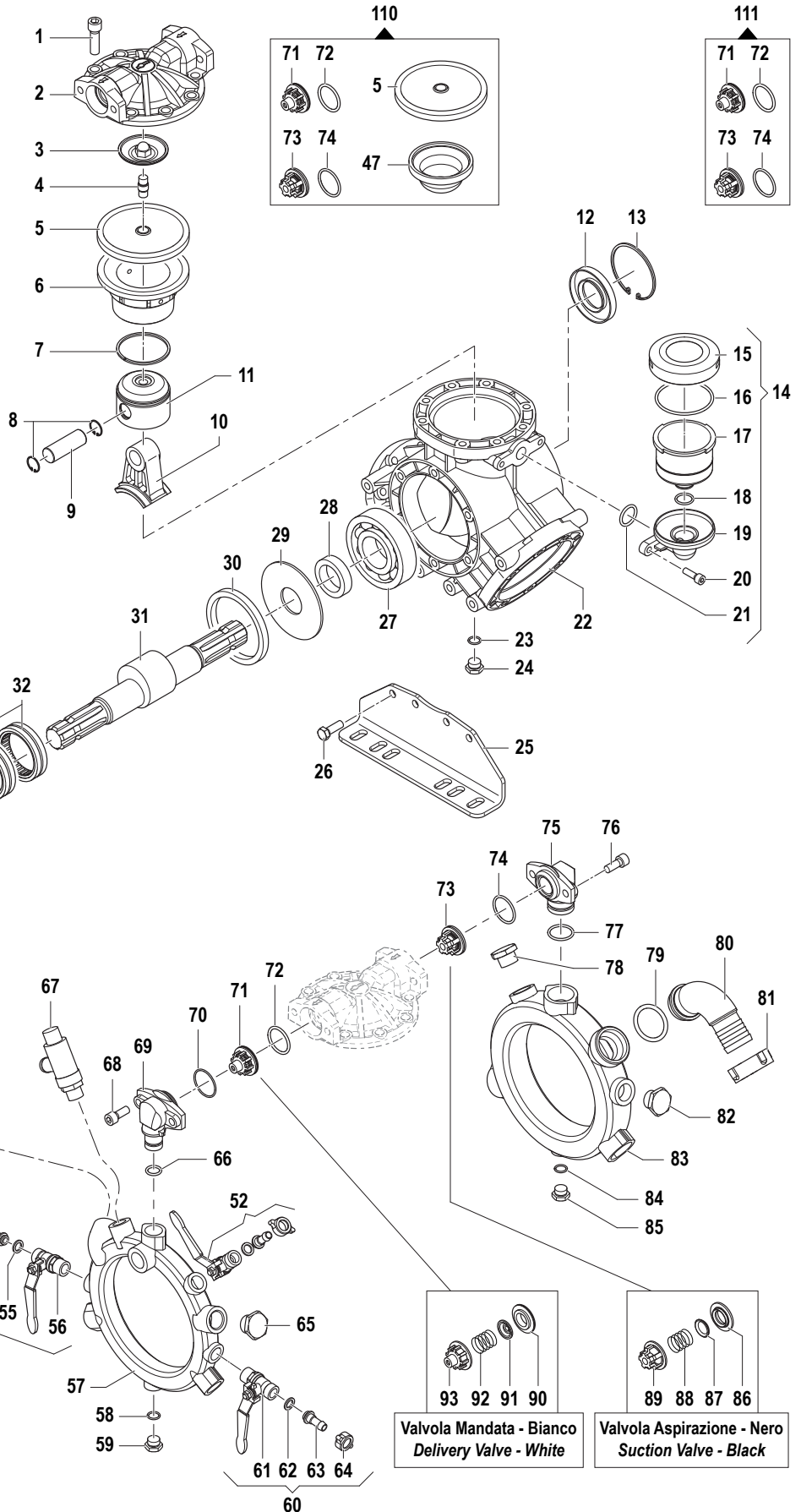
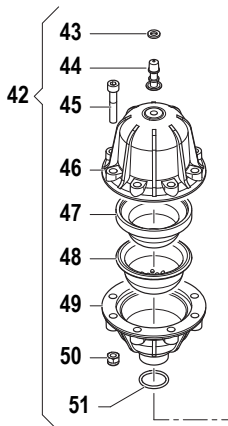

93 92 91 90
Valvola Mandata - Bianco
Delivery Valve - White

89 88 87 86
Valvola Aspirazione - Nero
Suction Valve - Black

Pompa Base
Standard Pump

Albero Passante 1"3/8 M-M
1"3/8 M-M Throughshaft

IDS 1201 - IDS 1401

550 RPM

N°	Cod.	Descrizione	Description	Note	Qty	Model
1	3609 0189	Vite	Screw	M12x40	24	
2	3218 0340	Testata Pompa	Pump Manifold		3	
3	0602 0056	Disco Tenuta Membrana	Disc		3	
4	2419 0042	Prigioniero	Stud Bolt	12MBx30	3	
5	1800 0012	Membrana Pompa	Pump Diaphragm	Gomma Nitrilica BUNA RUBBER	3	
	1800 0098	Membrana Pompa	Pump Diaphragm	Desmopan ®	3	
	1800 0103	Membrana Pompa	Pump Diaphragm	Viton ®	3	
6	0400 0083	Camicia	Piston Sleeve	Ø78	3	IDS1401
	0400 0082	Camicia	Piston Sleeve	Ø73	3	IDS1201
7	0020 0012	Anello Compressione	Compression Ring	Ø78	3	IDS1401
	0020 0013	Anello Compressione	Compression Ring	Ø73	3	IDS1201
8	3020 0022	Seeger Interno	Inner Seeger	Ø22	6	
9	3011 0025	Spinotto	Gudgeon Pin		3	IDS1401
	3011 0027	Spinotto	Gudgeon Pin		3	IDS1201
10	0205 0072	Kit Biella	Connecting Rod Assembly		1	
11	2409 0110	Pistone Guida	Piston	Ø78	3	IDS1401
	2409 0106	Pistone Guida	Piston	Ø73	3	IDS1201
12	0019 0087	Anello Tenuta	Oil Seal	Ø40x80x10	1	
13	3020 0032	Seeger Interno	Inner Seeger	Ø80	1	
14	1208 0023	Kit Compens. Volum.	Volum. Compensator Kit		1	
15	0402 0143	Coperchio Compens. Vol.	Volum. Compensator Cover		1	
16	1210 0373	Guarnizione OR	O-Ring	Ø3,53x73,03	1	
17	0421 0012	Compensat. Volumetr.	Volumetric Compensator		1	
18	1210 0002	Guarnizione OR	O-Ring	Ø2,62x20,7	1	
19	3002 0566	Supporto	Support		1	
20	3609 0002	Vite	Screw	M8x25	2	
21	1210 0110	Guarnizione OR	O-Ring	Ø3,53x24,99	1	
22	0403 0157	Carter Pompa	Pump Crankcase		1	
23	1210 0441	Guarnizione OR	O-Ring	Ø2x14	1	
24	3200 0007	Tappo	Plug	G3/8"	1	
25	2400 0095	Piede Sostegno Pompa	Pump Mounting Bracket		2	
26	3607 0220	Vite Testa Esagonale	Hexagonal Screw	M10x30	8	
27	0438 0088	Cuscinetto a Sfere	Ball Bearing	Ø40x110x27	1	
28	0601 0264	Distanziale	Spacer	Ø40,5xØ57x14	1	
29	2813 0030	Rondella Tenuta Biella	Connecting Rod Washer	Ø40x115x3,5	1	
30	0010 0003	Anello Tenuta Biella	Connecting Rod Ring	Ø109,5x93x10	1	
31	0001 0488	Albero Eccentrico	Eccentric Shaft	1"3/8 M-M	1	
32	0437 0078	Cuscinetto Rulli	Roller Bearing	Ø63x80x25	2	
33	0010 0003	Anello Tenuta Biella	Connecting Rod Ring	Ø109,5x93x10	1	
34	2813 0030	Rondella Tenuta Biella	Connecting Rod Washer	Ø40x115x3,5	1	
35	0601 0264	Distanziale	Spacer	Ø40,5xØ57x14	1	
36	0438 0088	Cuscinetto a Sfere	Ball Bearing	Ø40x110x27	1	
37	1210 0558	Guarnizione OR	O-Ring	Ø2,62x126,67	1	
38	0405 0069	Coperch. Sup. porta Cusc.	Support Cover		1	
39	3607 0220	Vite Testa Esagonale	Hexagonal Screw	M10x30	6	
40	3020 0011	Seeger Interno	Inner Seeger	Ø60	1	
41	0019 0068	Anello Tenuta	Oil Seal	Ø40x60x10	1	
42	1225 0026	Gruppo Accumul. Press.	Pressure Accumulator Assy		1	
43	1209 0033	Guarnizione	Gasket	Ø12x18x2	2	
44	3610 0003	Valvola Aria	Air Valve		1	
45	3609 0099	Vite	Screw	M8x45	8	
46	0003 0035	Accumulat. Press. Sup.	Pressure Accumulator		1	
47	1800 0177	Membrana Accumulatore	Accumulator Diaphragm		1	
48	0460 0037	Calotta Sostegno Membr.	Diaphragm Support Cap		1	
49	0002 0034	Accumulat. Press. Infer.	Pressure Accumulator		1	
50	0604 0039	Dado	Nut	M8x9,5	8	
51	1210 0033	Guarnizione OR	O-Ring	Ø3x28	1	
52	1214 0019	Gruppo Rubinetto SX	Complete Left Tap		2	
53	1200 0038	Galletto	Wing Nut	G1/2"	2	
54	2802 0018	Raccordo p.g. Mandata	Delivery Hose Tail	Ø8x10	2	
55	1209 0013	Guarnizione	Gasket	Ø12x18x2	2	
56	2826 0031	Rubinetto SX	Left Tap	G1/2-1/2"	2	
57	0415 0058	Collettore Mandata	Delivery Manifold		1	
58	1210 0441	Guarnizione OR	O-Ring	Ø2x14	1	
59	3200 0007	Tappo	Plug	G3/8"	1	
60	1214 0018	Gruppo Rubinetto DX	Complete Right Tap		1	
61	2826 0032	Rubinetto DX	Right Tap	G1/2-1/2"	1	
62	1209 0013	Guarnizione	Gasket	Ø12x18x2	1	
63	2802 0018	Raccordo p.g. Mandata	Delivery Hose Tail	Ø8x10	1	
64	1200 0038	Galletto	Wing Nut	G1/2"	1	
65	3200 0064	Tappo	Plug	G3/4" M	1	
66	1210 0003	Guarnizione OR	O-Ring	Ø3x16,2	3	
67	1219 0041	Gruppo Valvola Sicur.	Safety Valve Assembly	50 bar	1	
68	3609 0022	Vite	Screw	M10x25	6	
69	2806 0027	Raccordo Colleg. Mand.	Delivery Hose Tail for Valve		3	
70	1210 0090	Guarnizione OR	O-Ring	Ø2x38	3	

N°	Cod.	Descrizione	Description	Note	Qty	Model
71	1220 0093	Kit Valvola Mandata	Delivery Valve Kit	Bianco / White	3	Da Matricola / From Serial N. 41256684
72	1210 0018	Guarnizione OR	O-Ring	Ø3,53x34,52	3	
73	1220 0088	Kit Valvola Aspirazione	Suction Valve Kit	Nero / Black	3	Da Matricola / From Serial N. 41256684
74	1210 0011	Guarnizione OR	O-Ring	Ø3x36	3	
75	2806 0026	Raccordo Colleg. Aspiraz.	Suction Hose Tail for Valve		3	
76	3609 0022	Vite	Screw	M10x25	6	
77	1210 0498	Guarnizione OR	O-Ring	Ø3x30	3	
78	3200 0064	Tappo	Plug	G3/4" M	1	
79	1210 0200	Guarnizione OR	O-Ring	Ø2,62x42,52	1	
80	2801 0085	Racc. p.g. Asp. Curvo	Suction Elbow Tail	Ø33xØ40	1	
80	2801 0084	Racc. p.g. Asp. Curvo	Suction Elbow Tail	Ø28xØ36	1	
80	2801 0086	Racc. p.g. Asp. Curvo	Suction Elbow Tail	Ø38,5xØ45	1	
81	1200 0060	Galletto	Wing Nut	G1"3/4	1	
82	3202 0115	Tappo	Plug	G3/4" M	1	
83	0415 0060	Collettore Aspirazione	Suction Manifold		1	
84	1210 0441	Guarnizione OR	O-Ring	Ø2x14	1	
85	3200 0007	Tappo	Plug	G3/8"	1	
86	3009 0174	Sede Valv. Aspirazione	Suction Valve Seat		3	Da Matricola / From Serial N. 41256684
87	3604 0035	Valvola Aspirazione	Suction Valve		3	
88	1802 0286	Molla Valvola Regolaz.	Regulation Valve Spring		3	
89	1205 0050	Gabbia Valv. Aspirazione	Suction Valve Cage	Nero / Black	3	
90	3009 0123	Sede Valv. Mandata	Delivery Valve Seat		3	
91	3604 0009	Valvola Mandata	Delivery Valve		3	
92	1802 0015	Molla Valvola Regolaz.	Regulation Valve Spring		3	
93	1205 0005	Gabbia Valv. Mandata	Delivery Valve Cage	Bianco / White	3	

Varianti

Version

95	2806 0028	Raccordo Colleg. Mand.	Elbow Delivery Coupling	G3/4" F	1	
96	0001 0489	Albero Eccentrico	Eccentric Shaft	1"3/8 M - 1"3/8 F	1	
97	2813 0078	Rondella Tenuta Biella	Connecting Rod Washer	Ø50x115x3,5	1	
98	0601 0300	Distanziale	Spacer	Ø50,3xØ70x14	1	
99	0438 0033	Cuscinetto a Sfere	Ball Bearing	Ø50x110x27	1	
100	0019 0117	Anello Tenuta	Oil Seal	Ø50x80x10	1	

Kit

Optional

101	1009 0044	Flangia Calettata	Flange	1"3/8-6F	1	
102	2819 0001	Rosetta Elastica	Spring Washer	Ø10,5x17,5x2,2	1	
103	3609 0051	Vite	Screw	M10x90	1	
104	2424 0035	Puleggia	Pulley	3A - Øp350	1	
104	2424 0017	Puleggia	Pulley	3B - Øp290	1	
106	3609 0095	Vite	Screw	M10x50	3	
107	5001 0071	Kit Puleggia	Pulley Kit	3A - Øp350	1	
107	5001 0074	Kit Puleggia	Pulley Kit	3B - Øp290	1	

Kit Manutenzione

Maintenance Kit

110	5026 0367	Kit Ricambi Manutenzione	Ordinary Maintenance Kit		1	Da Matricola / From Serial N. 41256684
111	5025 0051	Kit Valvole Asp/mandata	Suction/Delivery Valve Kit		1	